

ROSSO MANIGLIE

ELEGANZA CON STILE

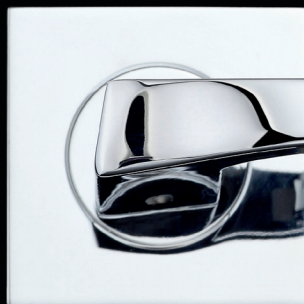

ITALIAN INSPIRED
DESIGN 2018

Available from J&P Hardware Limited

ROSSOMANIGLIE
ELEGANZA CON STILE

Rosso Maniglie is our exclusive range of Italian inspired designer levers. Produced using a zinc base material and manufactured to the highest standards, this range takes designer levers to the next level.

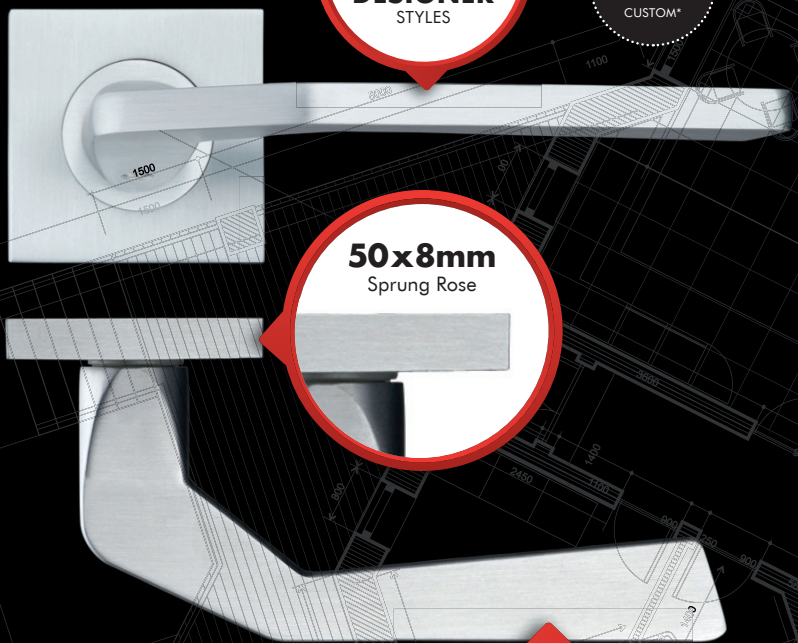

7

AVAILABLE

14
DESIGNER
STYLES

7

CUSTOM*

50x8mm
Sprung Rose

**Polished or
Satin Chrome**

Finishes Available

FEATURED PRODUCT

RMSQ140SC

*Customisable using the spare square rose packs - RMSQSR (see page 171)

For more information contact J&P Hardware on 0191 226 0476
info@jphardware.co.uk



RM010CP

RM010

Hydra lever – Screw on rose

PRODUCT CODES

- RM010CP
- RM010SC

KEY FEATURES

- 50 x 8mm round sprung rose
- Suitable for 35-54mm doors
- Includes fixings

FINISHES AVAILABLE



TECHNICAL

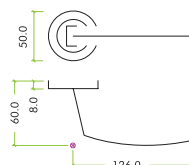

RM



RM020SC

RM020

Lupus lever – Screw on rose

PRODUCT CODES

- RM020CP
- RM020SC

KEY FEATURES

- 50 x 8mm round sprung rose
- Suitable for 35-54mm doors
- Includes fixings

FINISHES AVAILABLE



TECHNICAL

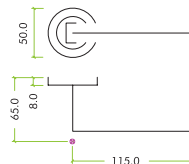



RM030CP

RM030

Pavo lever – Screw on rose

PRODUCT CODES

- RM030CP
- RM030SC

KEY FEATURES

- 50 x 8mm round sprung rose
- Suitable for 35-54mm doors
- Includes fixings

FINISHES AVAILABLE



TECHNICAL

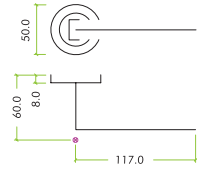

ACCESSORIES AVAILABLE

RMSQSR

Spare square
rose covers
pg.171



RM040CP

RM040

Cygnus lever – Screw on rose

PRODUCT CODES

- RM040CP
- RM040SC

KEY FEATURES

- 50 x 8mm round sprung rose
- Suitable for 35-54mm doors
- Includes fixings

FINISHES AVAILABLE



TECHNICAL

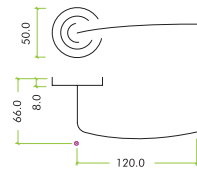

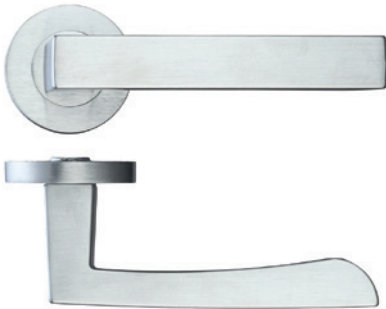

RM050SC

RM050

Mensa lever – Screw on rose

PRODUCT CODES

- RM050CP
- RM050SC

KEY FEATURES

- 50 x 8mm round sprung rose
- Suitable for 35-54mm doors
- Includes fixings

FINISHES AVAILABLE



TECHNICAL

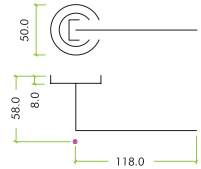

RM060CP

RM060

Aries lever – Screw on rose

PRODUCT CODES

- RM060CP
- RM060SC

KEY FEATURES

- 50 x 8mm round sprung rose
- Suitable for 35-54mm doors
- Includes fixings

FINISHES AVAILABLE



TECHNICAL

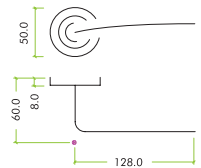



RM070SC

RM070

Corvus lever – Screw on rose

PRODUCT CODES

- RM070CP
- RM070SC

KEY FEATURES

- 50 x 8mm round sprung rose
- Suitable for 35-54mm doors
- Includes fixings

FINISHES AVAILABLE



CP SC

TECHNICAL

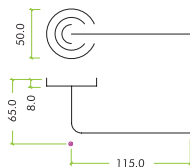

ACCESSORIES AVAILABLE

RMSQSR

Spare square
rose covers
pg.171



RM090CP

RM090

Lyra lever – Screw on rose

PRODUCT CODES

- RM090CP
- RM090SC

KEY FEATURES

- 50 x 8mm round sprung rose
- Suitable for 35-54mm doors
- Includes fixings

FINISHES AVAILABLE



CP SC

TECHNICAL

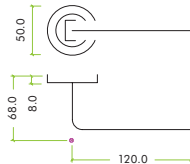



RM110SC

RM110

Aquila lever – screw on rose

PRODUCT CODES

- RM110CP
- RM110SC

KEY FEATURES

- 50 x 8mm round sprung rose
- Suitable for 35-54mm doors
- Includes fixings

FINISHES AVAILABLE



TECHNICAL

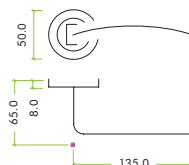

RM120CP

RM120

Vela lever – Screw on rose

PRODUCT CODES

- RM120CP
- RM120SC

KEY FEATURES

- 50 x 8mm round sprung rose
- Suitable for 35-54mm doors
- Includes fixings

FINISHES AVAILABLE



TECHNICAL

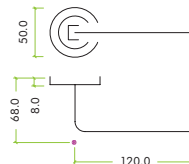



RM130SC

RM130

Draco lever – Screw on rose

PRODUCT CODES

- RM130CP
- RM130SC

KEY FEATURES

- 50 x 8mm round sprung rose
- Suitable for 35-54mm doors
- Includes fixings

FINISHES AVAILABLE



TECHNICAL

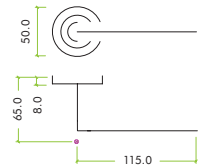

RM ESCUTCHEONS AND TURN & RELEASE

Screw on rose

PRODUCT CODES

- RM001CP
- RM001SC
- Euro profile
- RM002CP
- RM002SC
- Standard profile
- RM004CP
- RM004SC
- Turn & release with 5mm spindle

KEY FEATURES

- 50mm rose dia.
- Includes fixings

TECHNICAL



FINISHES AVAILABLE



RM001CP



RM002SC



RM004SCP



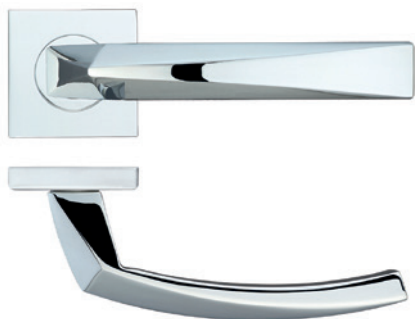

RMSQ010CP

RMSQ010

Hydra lever – Screw on rose

PRODUCT CODES

- RMSQ010CP
- RMSQ010SC

KEY FEATURES

- 50 x 8mm square sprung rose
- Suitable for 35-54mm doors
- Includes fixings

FINISHES AVAILABLE



TECHNICAL

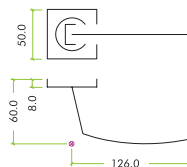

RMSQ020SC

RMSQ020

Lupus lever – Screw on rose

PRODUCT CODES

- RMSQ020CP
- RMSQ020SC

KEY FEATURES

- 50 x 8mm square sprung rose
- Suitable for 35-54mm doors
- Includes fixings

FINISHES AVAILABLE



TECHNICAL

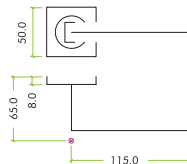



RMSQ050CP

RMSQ050

Mensa lever – Screw on rose

PRODUCT CODES

- RMSQ050CP
- RMSQ050SC

KEY FEATURES

- 50 x 8mm square sprung rose
- Suitable for 35-54mm doors
- Includes fixings

FINISHES AVAILABLE



CP SC

TECHNICAL

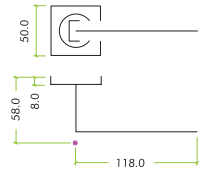

RM

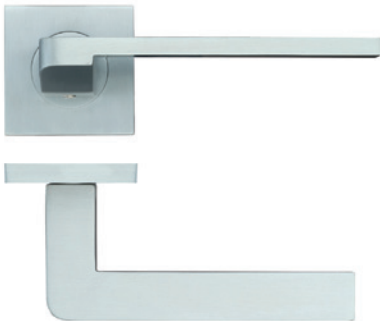

RMSQ080SC

RMSQ080

Maia lever – Screw on rose

PRODUCT CODES

- RMSQ080CP
- RMSQ080SC

KEY FEATURES

- 50 x 8mm square sprung rose
- Suitable for 35-54mm doors
- Includes fixings

FINISHES AVAILABLE



CP SC

TECHNICAL

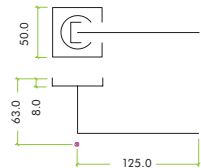



RMSQ090SC

RMSQ090

Lyra lever – Screw on rose

PRODUCT CODES

- RMSQ090CP
- RMSQ090SC

KEY FEATURES

- 50 x 8mm square sprung rose
- Suitable for 35-54mm doors
- Includes fixings

FINISHES AVAILABLE



CP SC

TECHNICAL

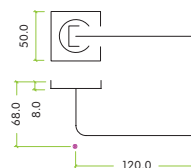

RMSQ100CP

RMSQ100

Dorado lever – Screw on rose

PRODUCT CODES

- RMSQ100CP
- RMSQ100SC

KEY FEATURES

- 50 x 8mm square sprung rose
- Suitable for 35-54mm doors
- Includes fixings

FINISHES AVAILABLE



CP SC

TECHNICAL

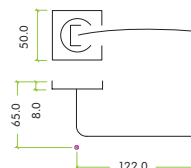

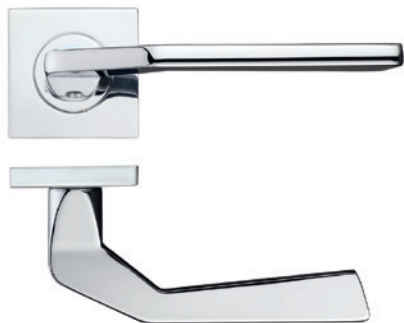

RMSQ140CP

RMSQ140

Auriga lever – Screw on rose

PRODUCT CODES

- RMSQ140CP
- RMSQ140SC

KEY FEATURES

- 50 x 8mm square sprung rose
- Suitable for 35-54mm doors
- Includes fixings

FINISHES AVAILABLE



TECHNICAL

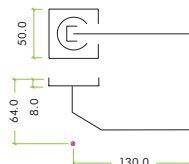

RM



RMSQ001SC



RMSQ002CP



RMSQ004SCP



RMSQ ESCUTCHEONS AND TURN & RELEASE

Screw on rose

PRODUCT CODES

- RMSQ001CP
- RMSQ001SC
- Euro profile
- RMSQ002CP
- RMSQ002SC
- Standard profile
- RMSQ004CP
- RMSQ004SC
- Turn & release with 5mm spindle

KEY FEATURES

- 50mm square rose
- Includes fixings

TECHNICAL



FINISHES AVAILABLE





RMSQSRCP

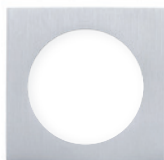

RMSQSRSC

RMSQSR / RMSQSR

Spare square rose pack

PRODUCT CODES

- RMSQSRCP
For lever on rose

- RMSQSRSC
For turn and release

TECHNICAL



KEY FEATURES

- 50 x 8mm square rose
- Suitable for replacing or customising levers or turn and releases

FINISHES AVAILABLE



CP SC

CUSTOMISATION OPTIONS

ROUND TO SQUARE

Change the look of a lever on round rose to a lever on square rose.

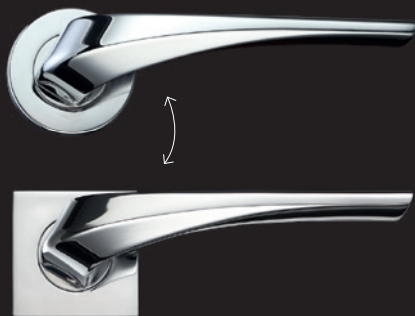

DUAL FINISH

Change the look of a lever by swapping the rose to a different finish.

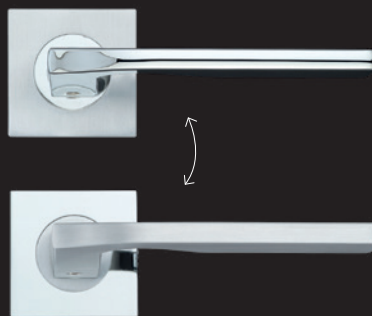



ARIES LEVER ON BACKPLATE

PRODUCT CODES

- RM061CP
Lock backplate
- RM061SC
Euro backplate
- RM062CP
Latch backplate
- RM062SC
Bathroom backplate
- RM063CP
- RM063SC

FINISHES AVAILABLE



KEY FEATURES

- 42 x 190mm backplate
- 47.5mm c/c (Euro)
- 57mm c/c (Lock & bath')
- Suitable for 35-54mm doors
- Includes fixings

TECHNICAL

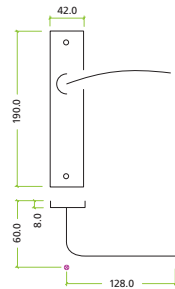

LYRA LEVER ON BACKPLATE

PRODUCT CODES

- RM091CP
Lock backplate
- RM091SC
Euro backplate
- RM092CP
Latch backplate
- RM092SC
Bathroom backplate
- RM093CP
- RM093SC

FINISHES AVAILABLE



KEY FEATURES

- 42 x 190mm backplate
- 47.5mm c/c (Euro)
- 57mm c/c (Lock & bath')
- Suitable for 35-54mm doors
- Includes fixings

TECHNICAL

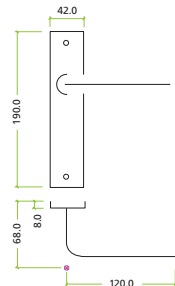



RMSQ133CP

DRACO LEVER ON BACKPLATE

PRODUCT CODES

- RM131CP
- RM131SC
Lock backplate
- RM131EPCP
- RM131EPSC
Euro backplate
- RM132CP
- RM132SC
Latch backplate
- RM133CP
- RM133SC
Bathroom backplate

FINISHES AVAILABLE



KEY FEATURES

- 42 x 190mm backplate
- 47.5mm c/c (Euro)
- 57mm c/c (Lock & bath')
- Suitable for 35-54mm doors
- Includes fixings

TECHNICAL

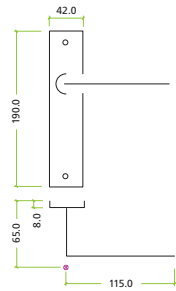

ADDITIONAL ACCESSORIES

- ZFP02SC Spare fixing pack - suitable for RM lever on rose and backplate
- ZFP02CP Spare fixing pack - suitable for RM lever on rose and backplate
- SP23 Spare spindle - 8mm x 8mm x 100mm long
- SP24 Spare spindle - 8mm x 8mm x 110mm long
- SP25 Spare spindle - 5mm x 5mm x 65mm long

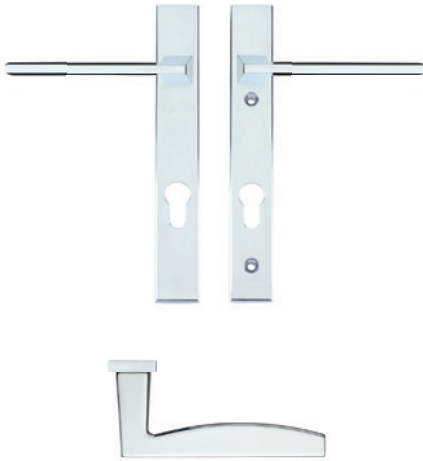

RM03NP92CP

PAVO LEVER ON NARROW BACKPLATE

PRODUCT CODES

- RM03NP92CP
- RM03NP92SC

KEY FEATURES

- 32 x 220mm backplate
- 92mm c/c (Euro)
- Unsprung non-handed lever
- Suitable for multi-point lock
- Includes fixings



REVERSIBLE

FINISHES AVAILABLE



CP SC

TECHNICAL

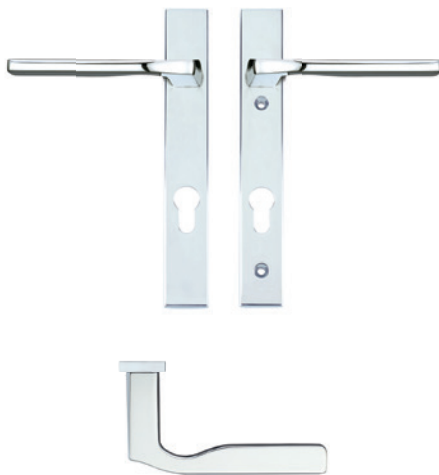
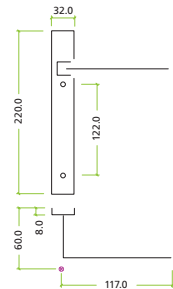

RM12NP92CP

VELA LEVER ON NARROW BACKPLATE

PRODUCT CODES

- RM12NP92CP
- RM12NP92SC

KEY FEATURES

- 32 x 220mm backplate
- 92mm c/c (Euro)
- Unsprung non-handed lever
- Suitable for multi-point lock
- Includes fixings



REVERSIBLE

FINISHES AVAILABLE



CP SC

TECHNICAL

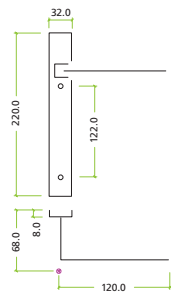



RM13NP92CP

DRACO LEVER ON NARROW BACKPLATE

PRODUCT CODES

- RM13NP92CP
- RM13NP92SC

KEY FEATURES

- 32 x 220mm backplate
- 92mm c/c (Euro)
- Unsprung non-handed lever
- Suitable for multi-point lock
- Includes fixings

**REVERSIBLE**

FINISHES AVAILABLE



CP SC

TECHNICAL

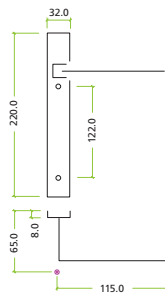

ROSSO **MANIGLIE**
ELEGANZA CON STILE

Available from

J&PHardware

Limited

t: 0191 226 0476

f: 0191 226 0491

e: info@jphardware.co.uk

**ITALIAN INSPIRED
DESIGN 2018**